

# Know Your Metal Shaper

By Sam Brown

**M**ILLING MACHINES and metal shapers do similar work in the machine shop, but in entirely different ways mechanically. A milling machine removes metal from the work by means of a rotating, multiple-toothed cutter mounted on a spindle, the speed of which is variable through a cone pulley and back gears. On the shaper, the cutting tool is carried on a ram which is driven back and forth, moving the single-point cutting tool across the surface of the work in a straight stroke. The single-point tool is one of the advantages of the shaper as it is inexpensive and permits fast setups on nearly all ordinary jobs. On a basic shaper operation, such as that in Fig. 5, the single-point tool removes metal faster than a milling cutter.

**Bench shaper:** A 7-in. shaper—one with a 7-in. maximum ram stroke—is a common choice for home model shops and small machine shops. Its main operating parts are shown in Fig. 1. The length of the ram stroke is easily adjusted by turning a crank on the side of the machine until the pointer is opposite the required stroke length indicated on a scale. The stroke of

the ram also can be positioned front or rear with relation to the table, Fig. 2. This is done by means of an adjusting stud on the top of the ram. Where the work will permit, always set the rear limit of the stroke as near the column as possible to avoid overhang of the ram. Most small shapers have four speeds ranging from 50 to 200 strokes per minute (average values). The machine table is fitted with power feed which can be set to feed from .005 to .030 per stroke, Fig. 3, the values varying with different makes of machines. The feed is reversible, right or left, and is timed to occur on the noncutting backstroke. The tool post is mounted on a swiveling clapper box, Fig. 4, which permits it to swing free on the backstroke. This prevents scoring the work, which would be likely if the tool were mounted rigidly.

**Planing a block:** Surfacing all six sides of a steel block is a typical shaper operation and as time is saved by working the cutting stroke the long way of the block, this job is carried out by turning the vise sidewise, Fig. 7. After the No. 1 side is planed, Fig. 6, it is placed against the fixed

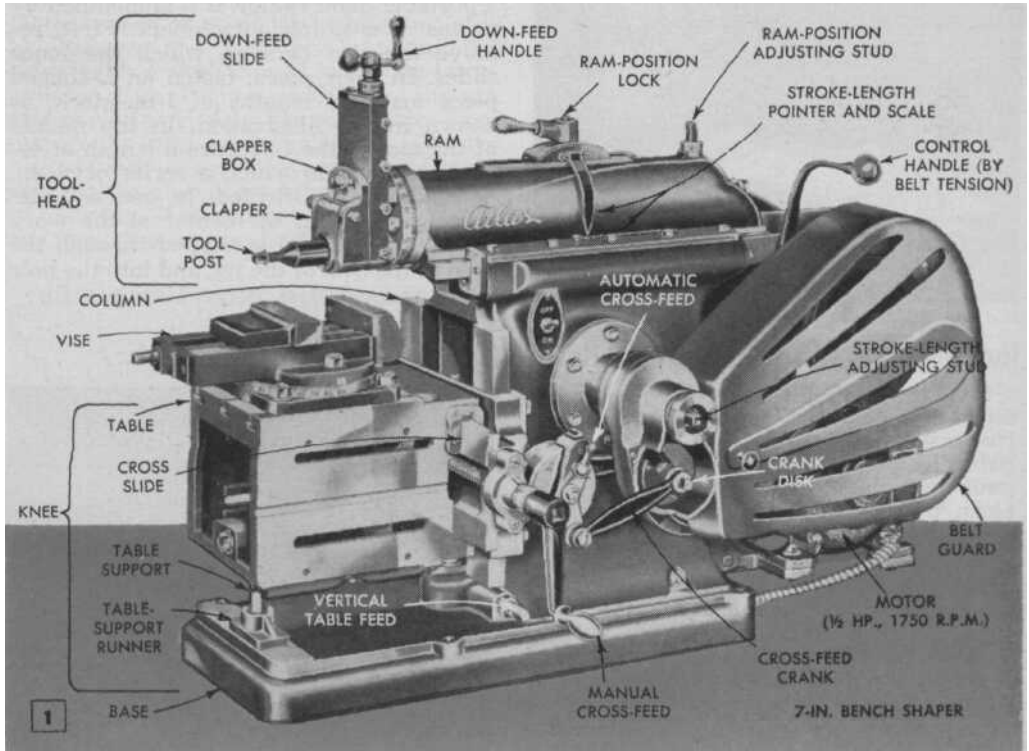

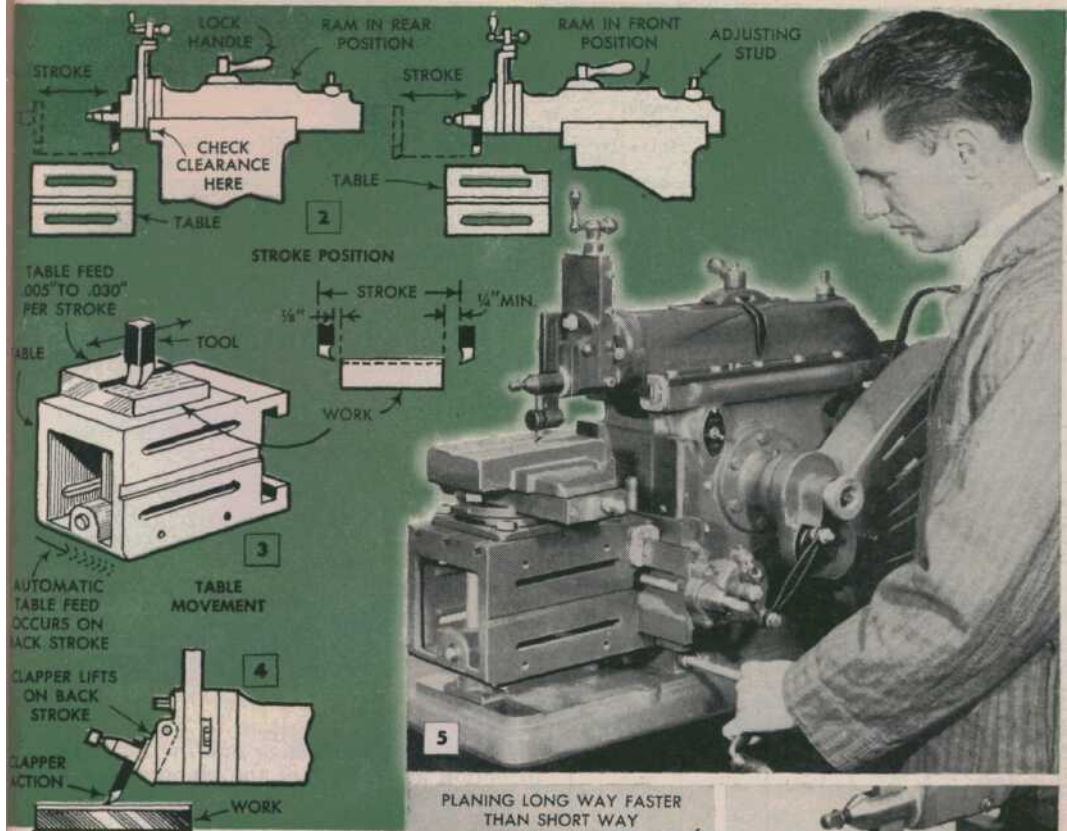

jaw of the vise as in Fig. 8. Side No. 3 is worked the same as side No. 2. It's important in such operations to keep the work seated true in the vise. This usually is done by tapping the work with a soft hammer as the vise is tightened, Fig. 9. Never strike the work a hard blow while it is on the machine table; a light tap does it. Where direct miking is required, Fig. 10, the work should be arranged to overhang the vise. The block shown is short enough so that ends numbered 5 and 6 can be worked with the piece held upright in the vise, Fig. 11. All surfaces are planed with the automatic feed, .010 to .015 being a good working value. Most operators prefer to cut from right to left, Figs. 5 and 7, as this allows the best view of the tool. Successive cuts are set by craning the table back by hand.

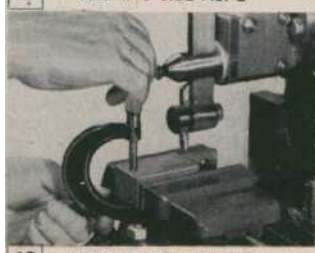
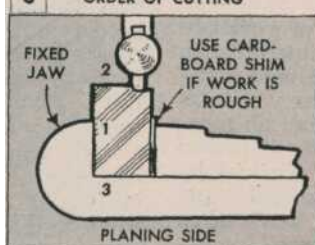
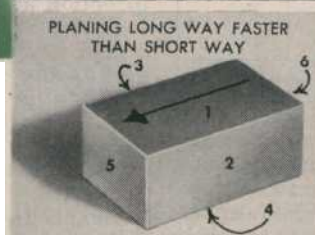

Recommended SHAPER SPEEDS <span style="float: right;">12</span>	
MATERIAL	F.P.M.
ALUMINUM	100 TO MAX.
SET PLASTICS	100 TO MAX.
THERMO PLASTICS	60 TO 120
YELLOW BRASS	80-100
CAST IRON	50-80
SOFT STEEL	40-70
MACHINE and LOW-CARBON STEEL	30-70
HARD STEEL	20-50
40 to 60 F.P.M. is practical working range for all machining materials	

13 FEET PER MINUTE SPEEDS								
Length of Stroke	NUMBER OF STROKES PER MINUTE							
	45		78		122		186	
	Forward Travel	Cutting Speed	Forward Travel	Cutting Speed	Forward Travel	Cutting Speed	Forward Travel	Cutting Speed
1"	4	7	7	13	10	19	16	30
2"	8	14	13	24	20	38	31	59
3"	11	21	20	36	30	57	47	86
4"	15	27	26	48	41	74	62	113
5"	19	34	33	58	51	91	78	139
6"	22	40	39	69	61	107	93	164
7"	26	45	46	77	71	121	108	184

Light-face figures are net feet cut per minute, calculated by multiplying length of stroke by number of strokes per minute.

Bold-face figures are cutting speeds in feet-per-minute — the same valuation which is used in pacing other machine tools.

14 INCHES PER MINUTE TABLE FEED				
FEED PER STROKE	STROKES PER MINUTE			
	45	78	122	186
.005"	¼"	⅜"	½"	"
.010"	½"	¾"	1¼"	1⅞"
.015"	"	1"	1⅞"	2¾"
.020"	⅞"	1½"	2½"	3¾"
.025"	1⅛"	2"	3"	4⅞"

Figures are approximate. Use this table to determine time required to traverse any specific width.

In some instances it is practical to make a cut with the table traveling in two directions. Work reversal is accomplished simply by shifting the reversing lever on the machine.

**Down-feeding:** Not all types of work can be mounted upright for surfacing cuts. In this case the tool is down-fed by hand, using the toolslide as in Fig. 15. In the work example shown in the detail, Fig. 15, sides numbered 1 to 4 are worked as in Figs. 6 to 11, but the ends 5 and 6 are worked by down-feeding. The cutting edge of the tool should incline away from the work as in the center detail, Fig. 15. Manual down-feeding on the shaper is perhaps the only operation where the hand remains on a moving part of the machine. It is quite safe if you use a slow ram speed and keep your eye on the job. A few minutes' practice will be required to get the feel of the moving ram. After that timing of the manual feed is easy, although it is advisable to use the slowest ram speed in the beginning, as the feed cannot be maintained at a precisely uniform rate.

**Clapper position:** When down feed is

used it is necessary to swivel the clapper box, Figs. 16 and 17. The correct position of the box is shown in the center detail, Fig. 16. In this position the tool will swing outward and away from the work on the backstroke. The tool can be worked as in the left-hand detail but there is some danger of scoring the work. Note, Figs. 16 and 17, that the tool swings out in the same direction as the top of the clapper box is inclined. Thus, if you are cutting the right end of work the clapper box must be swivelled to the right, Fig. 15, and if the cut is made to the left, the box is swivelled as in Fig. 16. Swivel the clapper box for all angular cuts, Figs. 27 and 28. Clapper-box swivel is sometimes used on flat surfacing jobs to clear the shoulder of the cut, Fig. 25.

**Shaper tools:** Cutting tools are similar to lathe tools and have a similar cutting action. Usually the tool bit is mounted in a holder, but larger tools are mounted directly in the tool post. The holder ordinarily is mounted with the tool at the front, but a reversed position, Fig. 18, is often useful when making finishing cuts. Tool shapes are variable, you can use almost any shape having clearance behind the cutting edge. Many shaper operators like the all-purpose tool detailed in Fig. 19. A side-rake tool, it cuts only to the left, the table moving to the right. It can be ground with both side rake and back rake. The round-nosed tool, Fig. 20 cuts right or left, while the finishing tool, Fig. 21, normally a square-nosed tool, is detailed with the edge ground for cutting to the left. Note that this is opposite to the angled edge of the all-purpose tool. The finishing tool makes a wide cut and will give a smooth finish with feeds up to maximum if you use a shallow cut not over .010.

**Internal cuts:** Various solid tools and

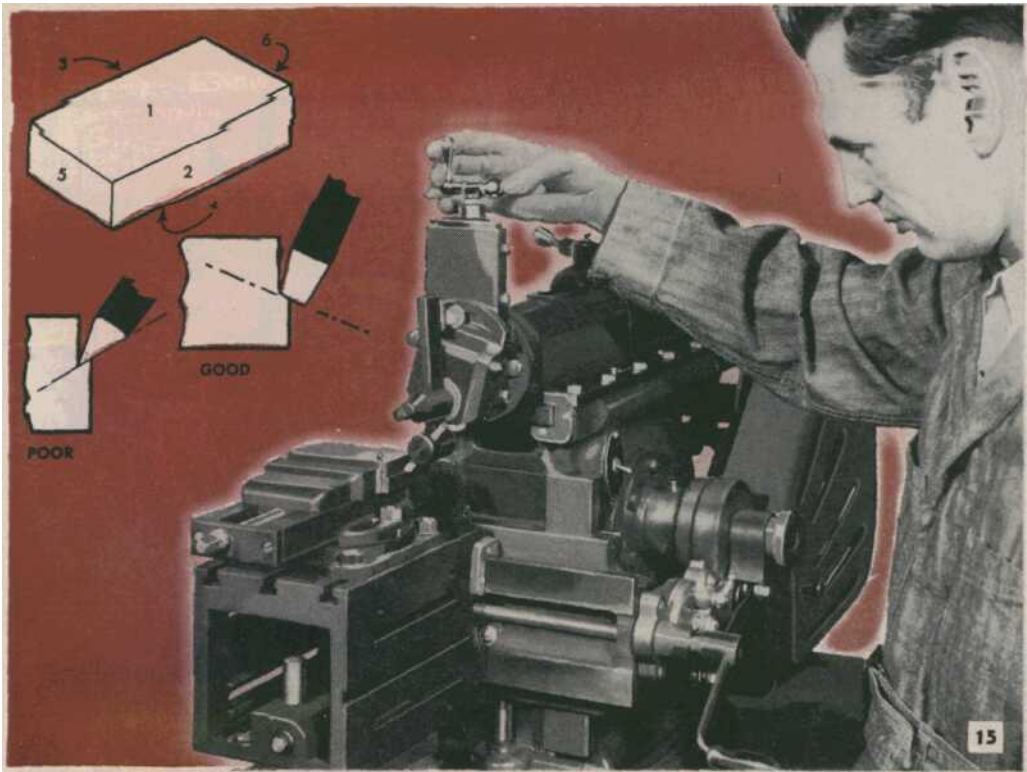

bars with inserted cutters are used for internal work, the general type of these accessories being the same as that used for boring in a lathe, Fig. 24. A common internal job is cutting a key seat, or keyway, Fig. 29. When the work opening is small the clapper must

be locked by fitting a metal bar behind the tool post as in Fig. 23. Down feed must be timed so that the tool clears the work, Figs. 22 and 24.

**Speeds:** The tables, Figs. 12, 13 and 14 will be useful in determining speeds for the common metals, feet-per-minute speeds and also determining the time required to traverse work of a given width. The typical jobs pictured and detailed in Figs. 25 to 29 inclusive, are good examples of the range of ordinary shaper work, but, of course, do not include special setups for machine and model parts. The shaper does excellent work on plastics and can even be used on hardwoods where cuts can be made with the grain.

**Operating Pointers:** In order to get the most out of the bench-type shaper in performance

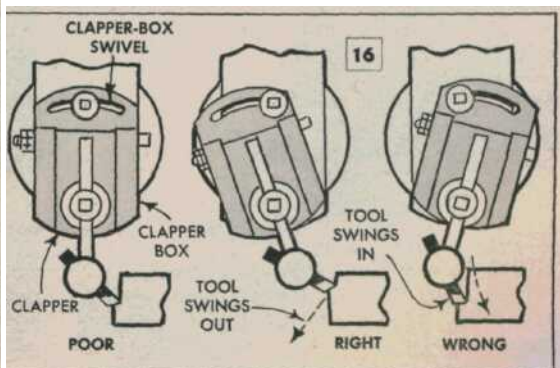
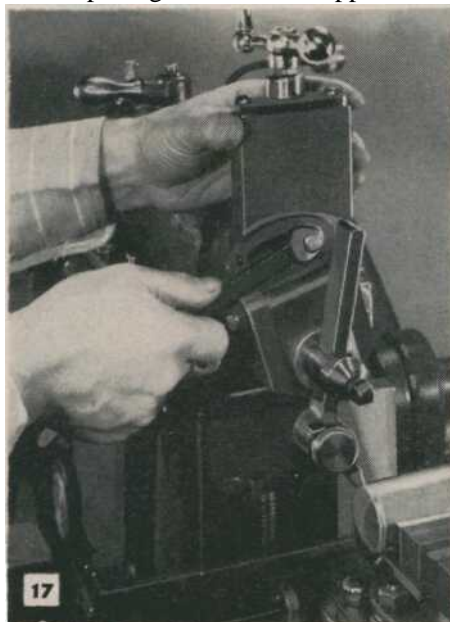

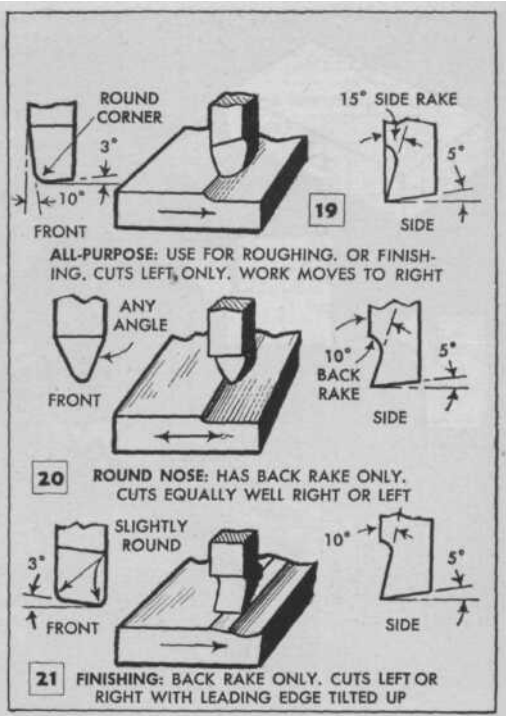
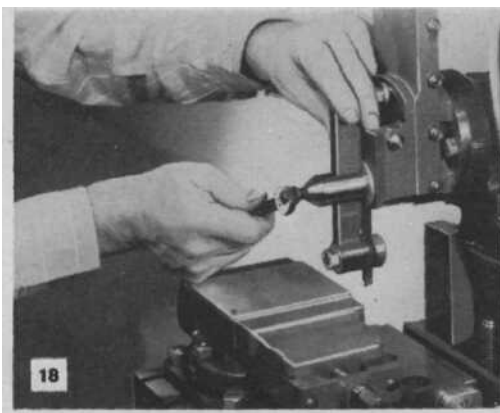

and accuracy, good practice requires that it be mounted on a rigid bench, or stand, with the table at a convenient height for mounting the work and making adjustments. The machine will not operate satisfactorily on an unstable bench or stand, especially at the higher ram speeds. When setting up the work and checking the operation of the ram, be sure that it is adjusted so that the cutting tool clears the work on the back stroke and that there is ample time at the end of the stroke for the clapper to drop before the tool again engages the work on the cutting stroke. Otherwise the clapper may not fully drop before the tool engages the work. The tool should just clear the work at the end of the cutting stroke. In most cases a longer stroke is unnecessary, except possibly in certain finishing operations. When grinding a round-nosed tool be sure that the cutting edge is ground and honed to a true radius. It is especially important when grinding to avoid the formation of tiny Vees in the cutting edge as a Vee may produce scores in the surface that are difficult to remove without remachining the entire surface. When bringing nonferrous metals to close dimensions, take light cuts. \* \* \*

Cutting tools used in shaper are similar to lathe cutting tools. Reversed position of holder, above left, is often useful when making finishing cuts

Internal cuts require extension bar and holder similar to that used in lathe. Typical setups are shown in lower photos. Note metal bar locking the clapper

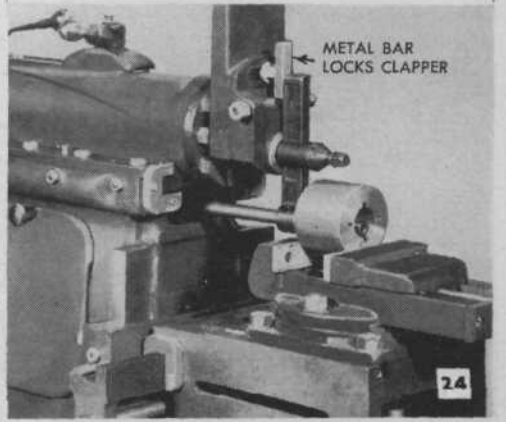
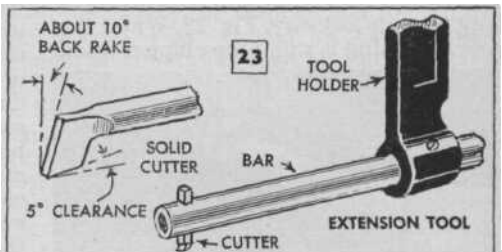
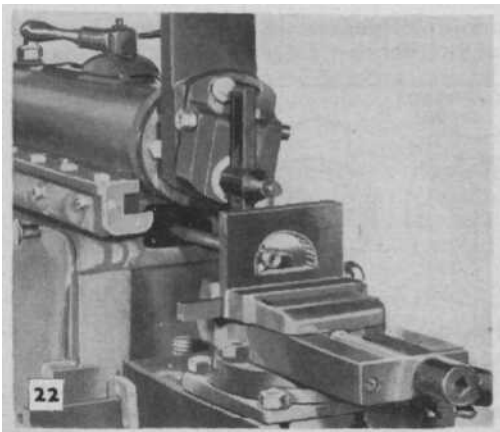

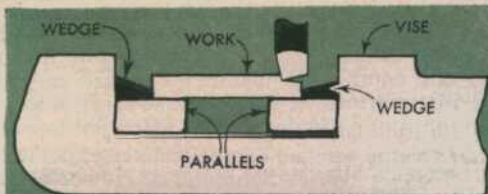

Thin work is mounted in vise with wedge blocks having one edge thinner than work for clearance. Direct mounting on machine table is practical. Plywood base is used under work to permit edge cuts

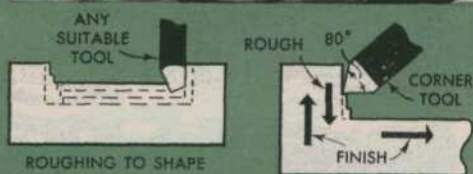
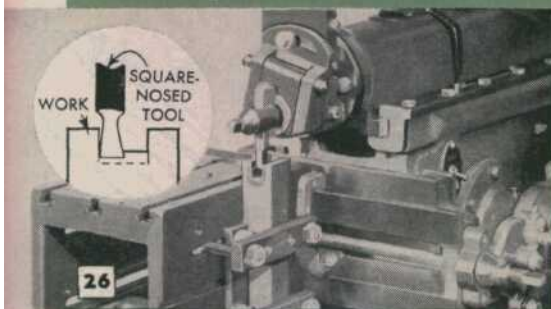
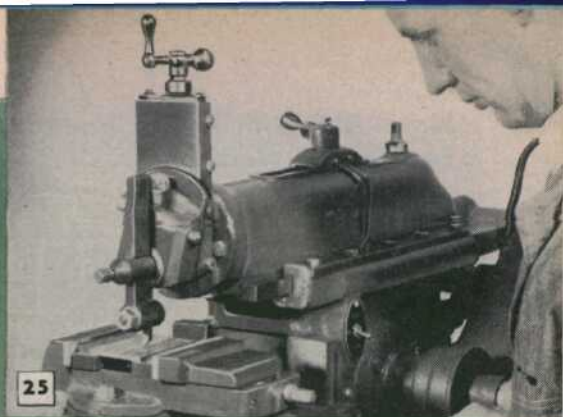

Right-angle corner is worked with square-nosed or corner tool. With edge slightly inclined tool will cut a very smooth surface with up-feed. Use down feed for the roughing cuts



A V-block is cut with the swiveling toolhead set at 45 deg. Work can be reversed in vise to finish second side rather than swinging toolhead. Automatic feed is used for roughing cuts



Dovetailing usually requires 60-deg. angle of swiveling head and is cut with tool ground to 50 deg. Roughing is done with forward edge of tool and finishing cuts are made with the side



Keyways are cut with square-nosed tools. Blind ends require drilled holes for clearance. Heel of tool, A, may require grinding to clear. Reversed toolholder helps to prevent chattering

